



Extract from our online catalogue:

ZWS-25/CI/QS

Current to: 2023-11-13



The zws sensors are among the smallest ultrasonic sensors available on the market in cuboidal housings with Teach-in buttons.

HIGHLIGHTS

- › Ultrasonic sensor in miniature housing
- › Installation-compatible with many optical sensors › a true alternative for critical applications
- › Up to 250 Hz switching frequency › for fast sampling
- › Optionally with SoundPipe zws1 waveguide attachment
- › New! Twin mode or external synchronisation via SyncBox2
- › Improved temperature compensation › adjustment to working conditions within 45 seconds
- › UL Listed to Canadian and US safety standards

BASICS

- › 1 switching output in pnp or npn variant
- › Analogue output 4–20 mA or 0–10 V
- › 6 detection ranges with a measurement range of 20 mm to 1 m
- › microsonic Teach-in by using a button
- › 20–30 V operating voltage

Description

The miniature sensor housing

of the zws-15 has dimensions of 20 mm x 32 mm x 12 mm. The housing's design and mounting is compatible with many optical sensors. This facilitates the conversion to ultrasonic sensors for critical applications.

For the zws sensor range

2 output versions and 6 detection ranges are available:



1 switching output, optionally in pnp or npn circuitry



1 analogue output 4–20 mA or 0–10 V

The Teach-in button

on the top facilitates the convenient setting of the sensor.

Two LEDs

in the sensor housing's upper half indicate the switching output and respectively the analogue output states.

The temperature compensation of the analogue sensors

profits from a significant improvement. The sensors reach their operating point only 45 seconds after switching on operating voltage.

The zws sensors with switching output have three operating modes:

- › Single switching point (Method A and B)
- › Two-way reflective barrier
- › Window mode

The operating mode single switching point (Method A)

is suitable for applications, in which the actual distance to the object is also the switching point. A typical application is level control, where the ultrasonic sensor detects the filling level vertically from above during the filling process. The taught switching point corresponds to the maximum filling level.

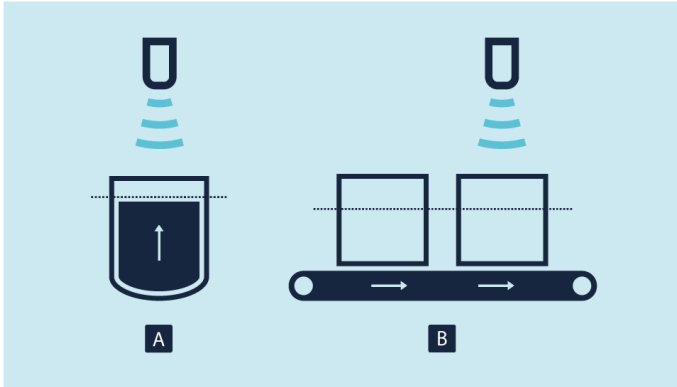

Teach-in of a switching point Method A and Method B

The operating mode single switching point +8 % (Method B)

is recommended by objects, which move into the detection area from the side. In this case the switching distance is set 8 % further than the actual measured distance to the object. This ensures a reliable switching distance even if the height of the objects varies slightly.

NEW! Twin mode or external synchronisation

If two switching zws sensors are operating too close to one another, twin mode can be selected to avoid mutual influences. This new feature is integrated in zws sensors from firmware V3.

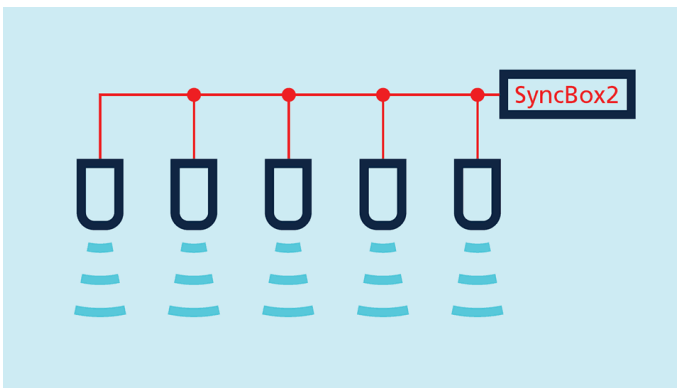

Synchronisation of up to 50 zws sensors

If more than two zws sensors need to be synchronised, the accessory **SyncBox2** can be used. The SyncBox2 generates a synchronisation signal output on pin 2. This permits up to 50 zws sensors to be autonomously synchronised.

High counting frequencies, short response times - no problem for the zws-7 ultrasonic sensor

zws-7: 250 Hz switching frequency for fast measurement

At a maximum detection range of 100 mm, the zws-7 can achieve a switching frequency of 250 Hz.

This allows both detection of objects with a high counting frequency and extremely narrow gaps between two objects at fast machinery speeds. The zws-7 responds under **3 ms**.

Additionally fitting the new **SoundPipe zws1** (Accessories) to the zws-7 markedly raises the power to detect narrow gaps between two objects at high machine speeds.

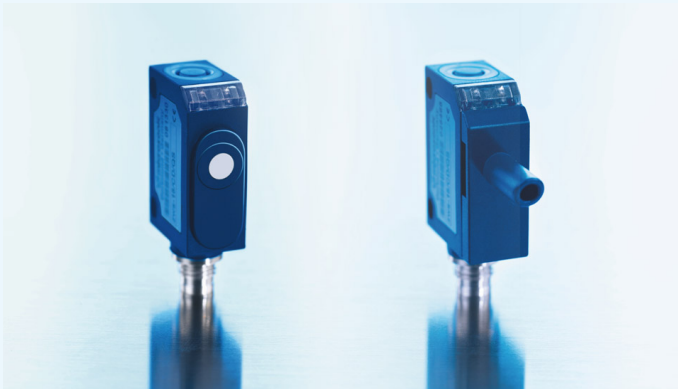

Fast zws-7 - Fast zws-7/-15 with SoundPipe



The zws-7, with a 250 Hz switching frequency, is particularly suitable for counting tasks at high machine speeds.

Technical data:

Operating range: 70 mm

Maximum range: 100 mm

Switching frequency: 250 Hz

Response time: < 3 ms

Set zws sensor via Teach-in procedure

The zws sensors with switching output have three operating modes:

- › Single switching point (Method A and B)
- › Two-way reflective barrier
- › Window mode

Teach-in of a single switching point (Method A)

by positioning the object to be detected within the desired distance (1) to the sensor, pressing the button for approx. 3 seconds and then pressing it once more for approx. 1 second. Ready.

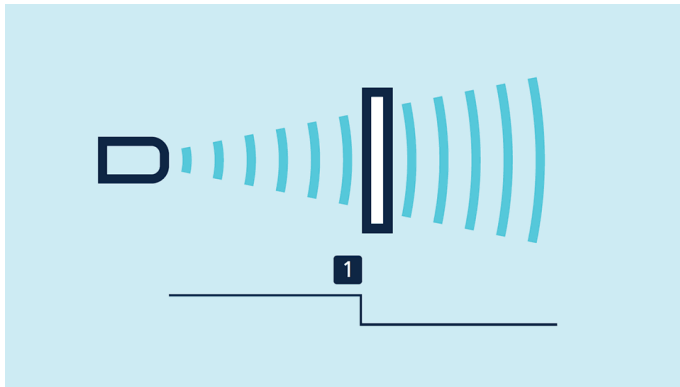

Teach-in of a switching point (Method A)

Teach-in of a single switching point +8 % (Method B)

by positioning the object to be detected within the desired distance (1) to the sensor, pressing the button for approx. 3 seconds and then pressing it once more for approx. 3 second. Ready.

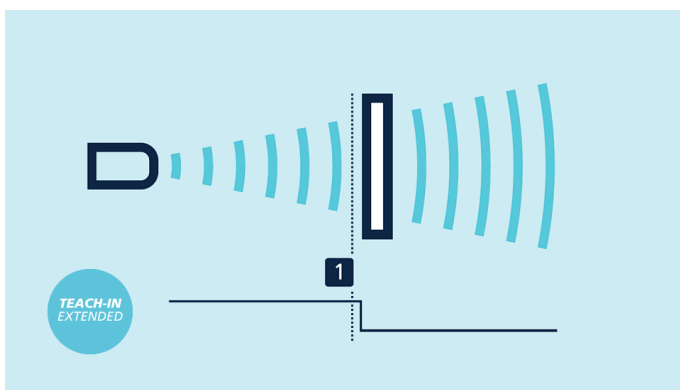

Teach-in of a switching point +8 % (Method B)

Teach-in of a two-way reflective barrier

with a fixed reflector can be set up with the help of a permanently mounted reflector by mounting the zws sensor and the reflector, then pressing the button for approx. 3 seconds and then pressing it once more for approx. 10 seconds. Now, the two-way reflective barrier has been set.

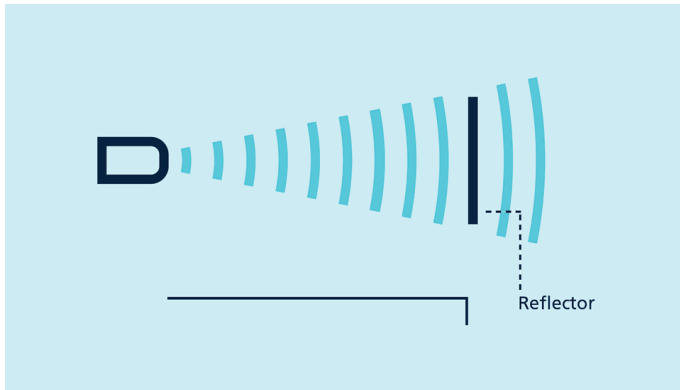

Teach-in of a two-way reflective barrier

Set the analogue output

by initially positioning the object to be detected on the sensor-close window limit (1), pressing the button for approx. 3 seconds, shifting the object to the sensor-distant window limit (2) and pressing the button once more for approx. 1 second. Ready.

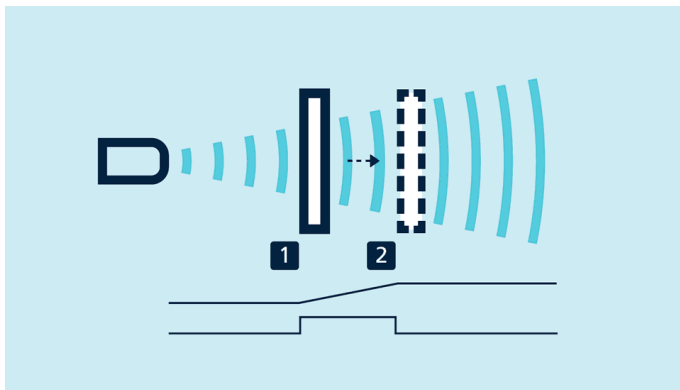

Teach-in of an analogue characteristic or of a window with two switching points

To set a window

with two detection points on a single switching output, the procedure is the same as setting the analogue.

NCC/NOC

and rising/falling analogue characteristic curve can also be set using the push-button.

zws-15 with SoundPipe - 1st place for sound field focusing (e.g. for level control)

Brings on intensively bundled sound field directly to the measuring point

The **SoundPipe zws1** (Accessories) can be used with any zws-15 or zws-7 sensor. It directs sound to the measuring point

thus allowing measurements to be taken in drill holes and openings with diameters under **5 mm**.

Measurement can be carried out directly before the sound exit opening, since the blind zone is inside the SoundPipe.

The SoundPipe zws1 is attached to the front of the zws-15 or zws-7 sensor.

A typical field of application is measuring levels in microplate wells which are used in medical analysis technology. The SoundPipe zws1 can be directly placed over the opening; this makes exact positioning that much easier. The attachment can also be used in scanning gaps of only a few millimetres in width between two objects.

The zws sensors are ideal for probing of circuit boards and wafers in the electronic industry or for use in packaging machines in which high-transparency films must be detected.

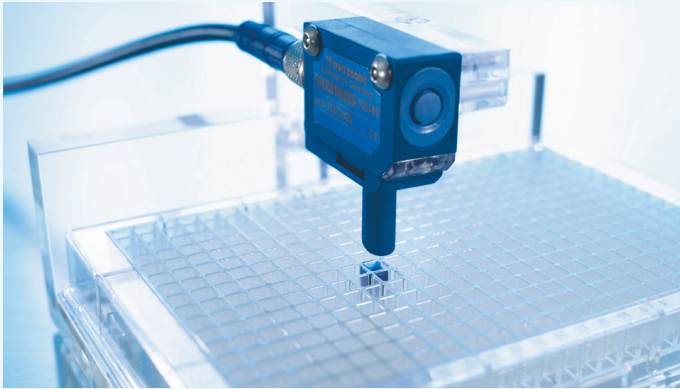

With the SoundPipe, the zws-15 sensor can measure fill levels in the smallest of openings.

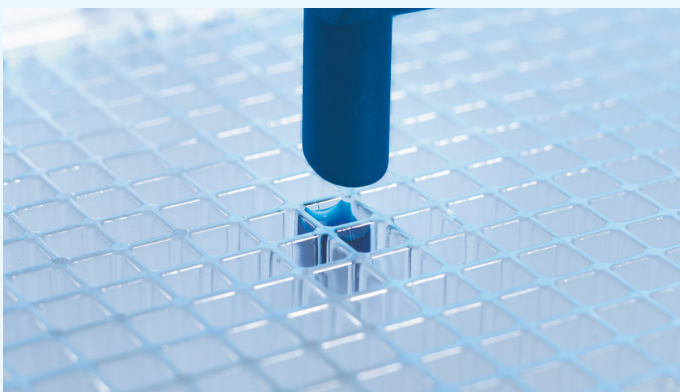

The SoundPipe is directly positioned over the measuring point.

zws-25/CI/QS

scale drawing

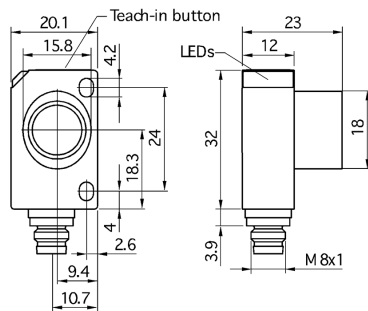

detection zone

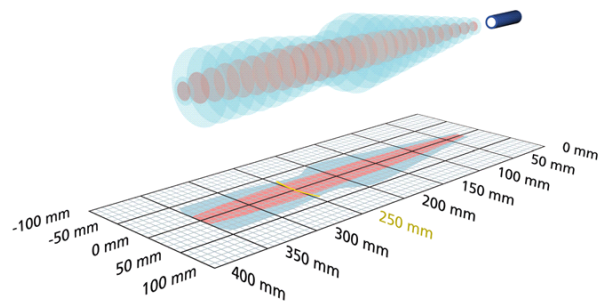

1 x analogue 4-20 mA



350 mm

| | |
|-----------------|---|
| measuring range | 30 - 350 mm |
| design | cuboidal |
| operating mode | analogue distance measurements |
| particularities | small cuboidal design narrow sound field |

ultrasonic-specific

| | |
|----------------------|--|
| means of measurement | echo propagation time measurement |
| transducer frequency | 320 kHz |
| blind zone | 30 mm |
| operating range | 250 mm |
| maximum range | 350 mm |
| resolution | 0.20 mm |
| reproducibility | ± 0.15 % |
| accuracy | ± 1 % (temperature drift internally compensated) |

electrical data

| | |
|-----------------------------|---|
| operating voltage U_B | 20 - 30 V d.c., reverse polarity protection |
| voltage ripple | ± 10 % |
| no-load current consumption | ≤ 25 mA |
| type of connection | 4-pin M8 initiator plug |

zws-25/CI/QS

outputs

| | |
|-----------------------------|--|
| output 1 | analogue output current: 4-20 mA switchable rising/falling |
| response time | 50 ms |
| delay prior to availability | < 300 ms |

inputs

| | |
|---------|-----------------------|
| input 1 | synchronisation input |
|---------|-----------------------|

housing

| | |
|---------------------------------|--|
| material | ABS |
| ultrasonic transducer | polyurethane foam, epoxy resin with glass contents |
| class of protection to EN 60529 | IP 67 |
| operating temperature | -25°C to +70°C |
| storage temperature | -40°C to +85°C |
| weight | 11 g |

technical features/characteristics

| | |
|--------------------------|--|
| temperature compensation | yes |
| controls | 1 push-button |
| scope for settings | Teach-in via push-button |
| Synchronisation | yes |
| multiplex | no |
| indicators | 1 x LED green: working, 1 x LED yellow: object in the window |
| particularities | small cuboidal design narrow sound field |

zws-25/CI/QS

pin assignment

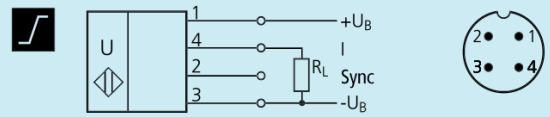

order no.

zws-25/CI/QS

The content of this document is subject to technical changes.
Specifications in this document are presented in a descriptive way
only. They do not warrant any product features.