



Extract from our online catalogue:

## pico+35/U

Current to: 2023-11-13



pico+ the "little guy" that can do it all: 4 ranges, 3 output signals, 2 housing variants and IO-Link interface.

## HIGHLIGHTS

- › Variant with 90° angled head
- › IO-Link interface › for support of the new industry standard
- › Automatic synchronisation and multiplex operation › for simultaneous operation of up to ten sensors in close quarters
- › UL Listed to Canadian and US safety standards
- › Improved temperature compensation › adjustment to working conditions within 120 seconds
- › Smart Sensor Profiles › more transparency between IO-Link Devices

## BASICS

- › 1 Push-Pull switching output › pnp or npn basis
- › Analogue output 4–20 mA or 0–10 V
- › 4 detection ranges with a measurement range of 20 mm to 1.3 m
- › microsonic Teach-in on pin 5
- › 0.069 mm to 0.1 mm resolution
- › 10–30 V operating voltage
- › LinkControl › for configuration of sensors from a PC

# Description

## The pico+ ultrasonic sensors

are a compact series with M18 threaded sleeves and a housing length of only 41 mm. In addition to the variants with an axial beam direction, there is also a housing variant with a 90° angled head and radial beam direction.

With four detection ranges from 20 mm to 1.3 m and three different output stages, this sensor family covers a wide range of applications.

Sensors with the Push-Pull output stage support SIO and IO link modes. Sensors with analogue output are optionally available with 4–20 mA current output or 0–10 V voltage output.

In SIO mode, sensors are configured using the microsonic Teach-in procedure on pin 5.

The sensors are Listed to applicable UL Standards and requirements by UL for Canada and the US.

## Two dual colour LEDs

### For the pico+ sensor family

there are 2 output stages and 4 detection ranges available:

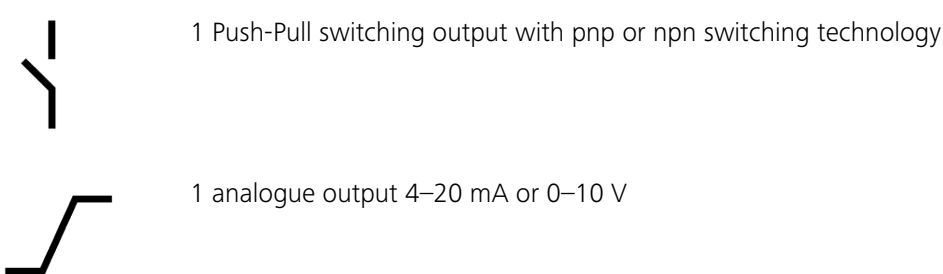

## Sensors with switching output have three operating modes:

- › Single switching point
- › Two-way reflective barrier
- › Window mode

## Teach-in of a single switching point

- › Place object to be detected (1) at the desired distance
- › Apply +U<sub>B</sub> to pin 5 for about 3 seconds
- › Then apply +U<sub>B</sub> to pin 5 again for about 1 seconds

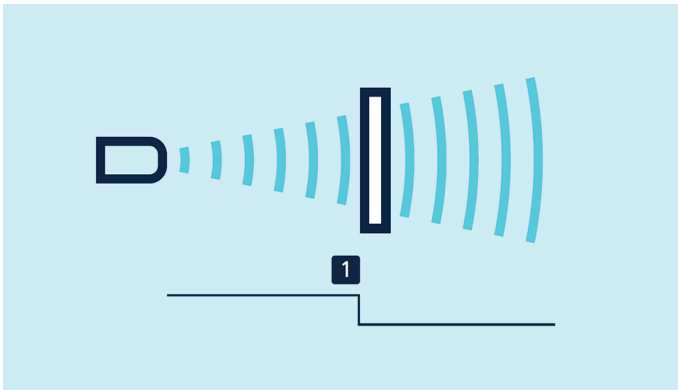

*Teach-in of a switching point*

### Teach-in of a two-way reflective barrier

with a fixed reflector

- › Apply  $+U_B$  to pin 5 for about 3 seconds
- › Then apply  $+U_B$  to pin 5 again for about 10 seconds

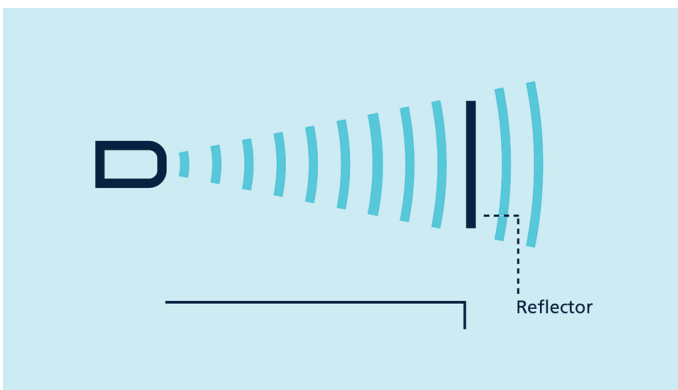

*Teach-in of a two-way reflective barrier*

### For configuration of a window

- › Place object at the near edge of the window (1)
- › Apply  $+U_B$  to pin 5 for about 3 seconds
- › Then move the object to the far edge of the window (2)
- › Then apply  $+U_B$  to pin 5 again for about 1 seconds

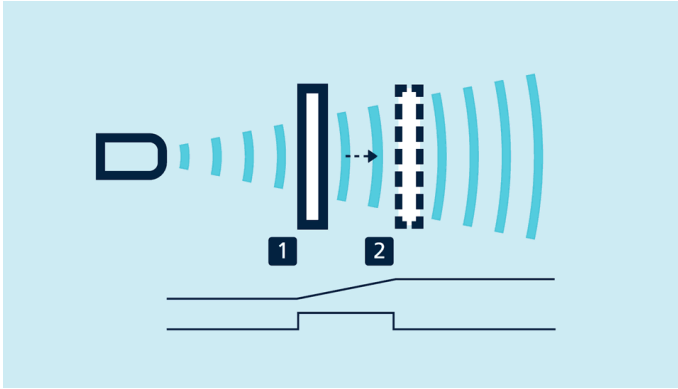

*Teach-in of an analogue characteristic or a window with two switching points*

### NCC/NOC

and rising/falling analogue characteristic curve can also be set via pin 5.

### One green and one yellow LED

indicate the state of the output and support microsonic Teach-in.

### LinkControl

optionally permits the extensive parameterisation of pico+ sensors. The LCA-2 **LinkControl adapter** , which is available as an accessory, can be used to connect pico+ sensors to the PC.



*Sensor connected to the PC via LCA-2 for programming*

### Easy to synchronise

A number of pico+ sensors can be run closely packed in applications synchronised to stop them from influencing one another. To this end, the sync mode has to be activated and all the sensors are to be electrically connected one to another with pin 5.

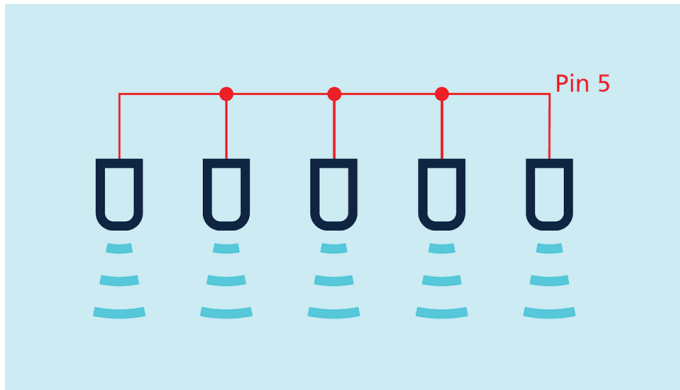

*Synchronisation using pin 5*

If more than 10 sensors must be synchronised, this can be carried out with the **SyncBox1** , which is available as an accessory.

In instances of where a number of sensors are run at an IO-Link master, then the master's function is to assume synchronisation.



*Synchronised sensor cell in glass bottle production*

### Updated to IO-Link version 1.1

The pico+ sensors with the extension „/A“ in the order name are updated to IO-Link version 1.1 and support the Smart Sensor Profile. Please note that these sensor with the updated IO-Link version do not support IO-Link version 1.0 any longer. For example, when replacing pico+15/F with a **pico+15/F/A** you have to integrate the new device ID in the IO-Link master. In SIO mode, the sensors are compatible with each other. The predecessor models pico+xxx/F can be found in the [sensor archive](#).

# pico+35/U

## scale drawing

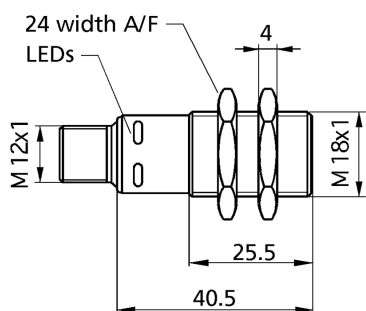

## detection zone

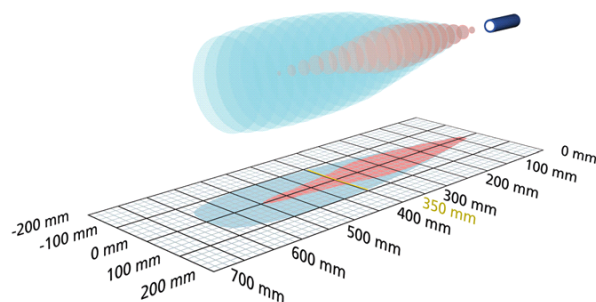

1 x analogue 0-10 V



600 mm

measuring range	65 - 600 mm
design	cylindrical M18
operating mode	analogue distance measurements
particularities	UL Listed

## ultrasonic-specific

means of measurement	echo propagation time measurement
transducer frequency	400 kHz
blind zone	65 mm
operating range	350 mm
maximum range	600 mm
resolution	0.069 mm to 0.17 mm, depending on the analogue window
reproducibility	± 0.15 %
accuracy	± 1 % (temperature drift internally compensated)

## electrical data

operating voltage $U_b$	15 V bis 30 V DC, verpolfest
voltage ripple	± 10 %
no-load current consumption	≤ 40 mA
type of connection	5-pin M12 initiator plug

# pico+35/U

## outputs

output 1	analogue output voltage: 0-10 V, short-circuit-proof switchable rising/falling
response time	64 ms
delay prior to availability	< 300 ms

## inputs

input 1	com input synchronisation input teach-in input
---------	--

## housing

material	brass sleeve, nickel-plated, plastic parts, PBT
ultrasonic transducer	polyurethane foam, epoxy resin with glass contents
max. tightening torque of nuts	15 Nm
class of protection to EN 60529	IP 67
operating temperature	-25°C to +70°C
storage temperature	-40°C to +85°C
weight	30 g
further versions	90° angular head
further versions	<a href="#">pico+35/WK/U</a>

## technical features/characteristics

temperature compensation	yes
controls	com input
scope for settings	Teach-in via com input on pin 5 LCA-2 with LinkControl
Synchronisation	yes
multiplex	yes
indicators	1 x LED green: working, 1 x LED yellow: object in the window
particularities	UL Listed



# pico+35/U

## pin assignment

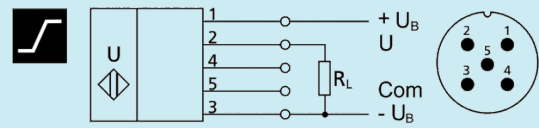

order no.

**pico+35/U**

The content of this document is subject to technical changes.  
Specifications in this document are presented in a descriptive way  
only. They do not warrant any product features.