



Extract from our online catalogue:

pico+35/I

Current to: 2023-11-13



pico+ the "little guy" that can do it all: 4 ranges, 3 output signals, 2 housing variants and IO-Link interface.

## HIGHLIGHTS

- › Variant with 90° angled head
- › IO-Link interface › for support of the new industry standard
- › Automatic synchronisation and multiplex operation › for simultaneous operation of up to ten sensors in close quarters
- › UL Listed to Canadian and US safety standards
- › Improved temperature compensation › adjustment to working conditions within 120 seconds
- › Smart Sensor Profiles › more transparency between IO-Link Devices

## BASICS

- › 1 Push-Pull switching output › pnp or npn basis
- › Analogue output 4–20 mA or 0–10 V
- › 4 detection ranges with a measurement range of 20 mm to 1.3 m
- › microsonic Teach-in on pin 5
- › 0.069 mm to 0.1 mm resolution
- › 10–30 V operating voltage
- › LinkControl › for configuration of sensors from a PC

# Description

## The pico+ ultrasonic sensors

are a compact series with M18 threaded sleeves and a housing length of only 41 mm. In addition to the variants with an axial beam direction, there is also a housing variant with a 90° angled head and radial beam direction.

With four detection ranges from 20 mm to 1.3 m and three different output stages, this sensor family covers a wide range of applications.

Sensors with the Push-Pull output stage support SIO and IO link modes. Sensors with analogue output are optionally available with 4–20 mA current output or 0–10 V voltage output.

In SIO mode, sensors are configured using the microsonic Teach-in procedure on pin 5.

The sensors are Listed to applicable UL Standards and requirements by UL for Canada and the US.

## Two dual colour LEDs

### For the pico+ sensor family

there are 2 output stages and 4 detection ranges available:



1 Push-Pull switching output with pnp or npn switching technology



1 analogue output 4–20 mA or 0–10 V

## Sensors with switching output have three operating modes:

- › Single switching point
- › Two-way reflective barrier
- › Window mode

## Teach-in of a single switching point

- › Place object to be detected (1) at the desired distance
- › Apply +U<sub>B</sub> to pin 5 for about 3 seconds
- › Then apply +U<sub>B</sub> to pin 5 again for about 1 seconds

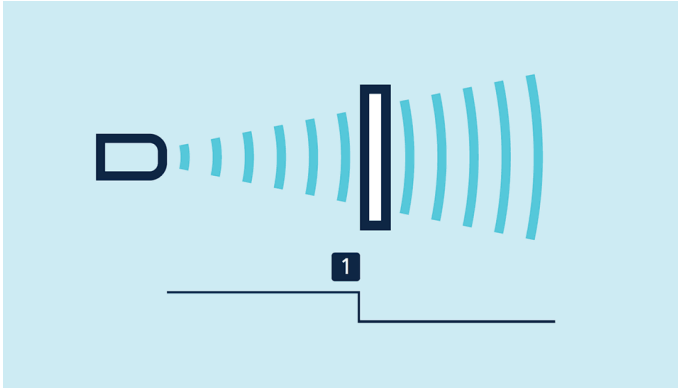

*Teach-in of a switching point*

### Teach-in of a two-way reflective barrier

with a fixed reflector

- › Apply  $+U_B$  to pin 5 for about 3 seconds
- › Then apply  $+U_B$  to pin 5 again for about 10 seconds

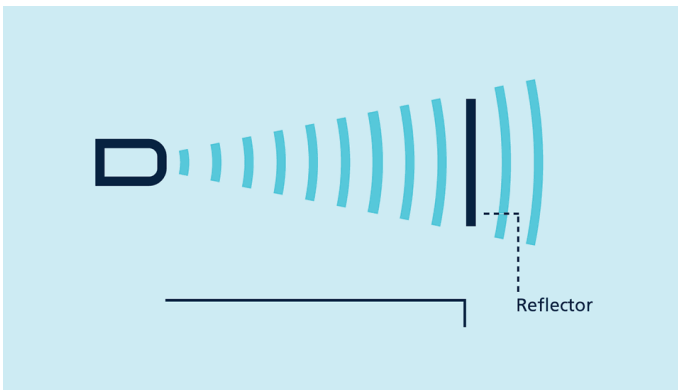

*Teach-in of a two-way reflective barrier*

### For configuration of a window

- › Place object at the near edge of the window (1)
- › Apply  $+U_B$  to pin 5 for about 3 seconds
- › Then move the object to the far edge of the window (2)
- › Then apply  $+U_B$  to pin 5 again for about 1 seconds

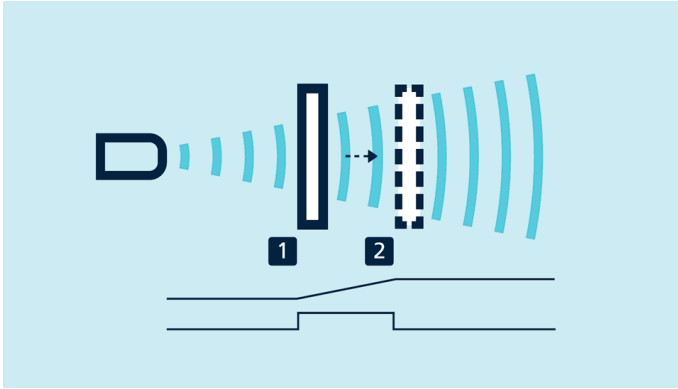

*Teach-in of an analogue characteristic or a window with two switching points*

### NCC/NOC

and rising/falling analogue characteristic curve can also be set via pin 5.

### One green and one yellow LED

indicate the state of the output and support microsonic Teach-in.

### LinkControl

optionally permits the extensive parameterisation of pico+ sensors. The LCA-2 **LinkControl adapter** , which is available as an accessory, can be used to connect pico+ sensors to the PC.



*Sensor connected to the PC via LCA-2 for programming*

### Easy to synchronise

A number of pico+ sensors can be run closely packed in applications synchronised to stop them from influencing one another. To this end, the sync mode has to be activated and all the sensors are to be electrically connected one to another with pin 5.

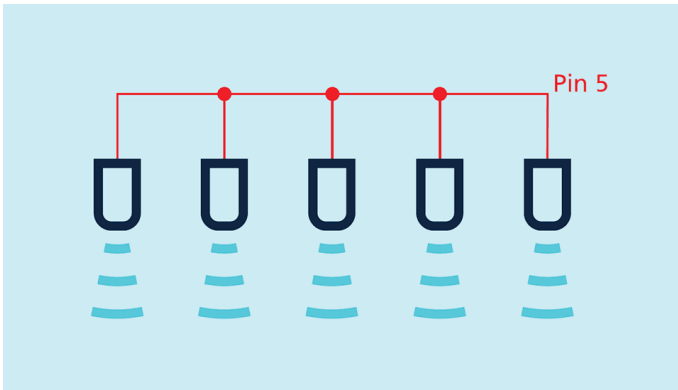

*Synchronisation using pin 5*

If more than 10 sensors must be synchronised, this can be carried out with the **SyncBox1** , which is available as an accessory.

In instances of where a number of sensors are run at an IO-Link master, then the master's function is to assume synchronisation.



*Synchronised sensor cell in glass bottle production*

### Updated to IO-Link version 1.1

The pico+ sensors with the extension „/A“ in the order name are updated to IO-Link version 1.1 and support the Smart Sensor Profile. Please note that these sensor with the updated IO-Link version do not support IO-Link version 1.0 any longer. For example, when replacing pico+15/F with a **pico+15/F/A** you have to integrate the new device ID in the IO-Link master. In SIO mode, the sensors are compatible with each other. The predecessor models pico+xxx/F can be found in the [sensor archive](#).

# pico+35/I

## scale drawing

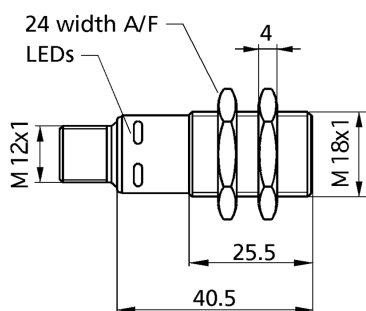

## detection zone

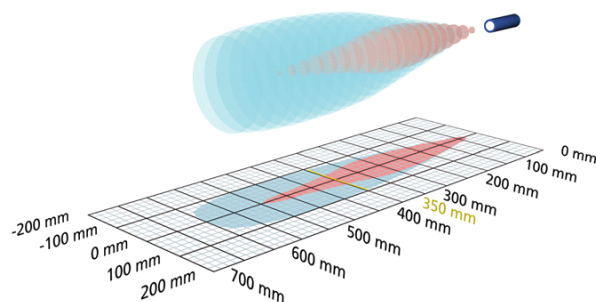

1 x analogue 4-20 mA



600 mm

|                 |                                |
|-----------------|--------------------------------|
| measuring range | 65 - 600 mm                    |
| design          | cylindrical M18                |
| operating mode  | analogue distance measurements |
| particularities | UL Listed                      |

## ultrasonic-specific

|                      |   |
|----------------------|---|
| means of measurement | echo propagation time measurement                     |
| transducer frequency | 400 kHz   |
| blind zone           | 65 mm   |
| operating range      | 350 mm  |
| maximum range        | 600 mm  |
| resolution           | 0.069 mm to 0.17 mm, depending on the analogue window |
| reproducibility      | ± 0.15 %  |
| accuracy             | ± 1 % (temperature drift internally compensated)      |

## electrical data

|                             |   |
|-----------------------------|---|
| operating voltage $U_b$     | 10 - 30 V d.c., reverse polarity protection |
| voltage ripple              | ± 10 %                                      |
| no-load current consumption | ≤ 40 mA                                     |
| type of connection          | 5-pin M12 initiator plug                    |

# pico+35/I

## outputs

|                             |  |
|-----------------------------|--|
| output 1                    | analogue output<br>current: 4-20 mA<br>switchable rising/falling |
| response time               | 64 ms  |
| delay prior to availability | < 300 ms   |

## inputs

|         |  |
|---------|--|
| input 1 | com input<br>synchronisation input<br>teach-in input |
|---------|--|

## housing

|                                 |  |
|---------------------------------|--|
| material                        | brass sleeve, nickel-plated, plastic parts, PBT    |
| ultrasonic transducer           | polyurethane foam, epoxy resin with glass contents |
| max. tightening torque of nuts  | 15 Nm  |
| class of protection to EN 60529 | IP 67  |
| operating temperature           | -25°C to +70°C                                     |
| storage temperature             | -40°C to +85°C                                     |
| weight                          | 30 g   |
| further versions                | 90° angular head                                   |
| further versions                | <a href="#">pico+35/WK/I</a>                       |

## technical features/characteristics

|                          |  |
|--------------------------|--|
| temperature compensation | yes  |
| controls                 | com input  |
| scope for settings       | Teach-in via com input on pin 5<br>LCA-2 with LinkControl    |
| Synchronisation          | yes  |
| multiplex                | yes  |
| indicators               | 1 x LED green: working, 1 x LED yellow: object in the window |
| particularities          | UL Listed  |



# pico+35/I

## pin assignment

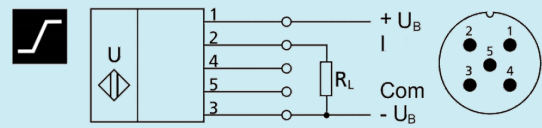

order no.

**pico+35/I**

The content of this document is subject to technical changes.  
Specifications in this document are presented in a descriptive way  
only. They do not warrant any product features.