



Extract from our online catalogue:

pico+15/F/A

Current to: 2023-11-13



pico+ the "little guy" that can do it all: 4 ranges, 3 output signals, 2 housing variants and IO-Link interface.

HIGHLIGHTS

- › Variant with 90° angled head
- › IO-Link interface › for support of the new industry standard
- › Automatic synchronisation and multiplex operation › for simultaneous operation of up to ten sensors in close quarters
- › UL Listed to Canadian and US safety standards
- › Improved temperature compensation › adjustment to working conditions within 120 seconds
- › Smart Sensor Profiles › more transparency between IO-Link Devices

BASICS

- › 1 Push-Pull switching output › pnp or npn basis
- › Analogue output 4–20 mA or 0–10 V
- › 4 detection ranges with a measurement range of 20 mm to 1.3 m
- › microsonic Teach-in on pin 5
- › 0.069 mm to 0.1 mm resolution
- › 10–30 V operating voltage
- › LinkControl › for configuration of sensors from a PC

Description

The pico+ ultrasonic sensors

are a compact series with M18 threaded sleeves and a housing length of only 41 mm. In addition to the variants with an axial beam direction, there is also a housing variant with a 90° angled head and radial beam direction.

With four detection ranges from 20 mm to 1.3 m and three different output stages, this sensor family covers a wide range of applications.

Sensors with the Push-Pull output stage support SIO and IO link modes. Sensors with analogue output are optionally available with 4–20 mA current output or 0–10 V voltage output.

In SIO mode, sensors are configured using the microsonic Teach-in procedure on pin 5.

The sensors are Listed to applicable UL Standards and requirements by UL for Canada and the US.

Two dual colour LEDs

For the pico+ sensor family

there are 2 output stages and 4 detection ranges available:



1 Push-Pull switching output with pnp or npn switching technology



1 analogue output 4–20 mA or 0–10 V

Sensors with switching output have three operating modes:

- › Single switching point
- › Two-way reflective barrier
- › Window mode

Teach-in of a single switching point

- › Place object to be detected (1) at the desired distance
- › Apply +U_B to pin 5 for about 3 seconds
- › Then apply +U_B to pin 5 again for about 1 seconds

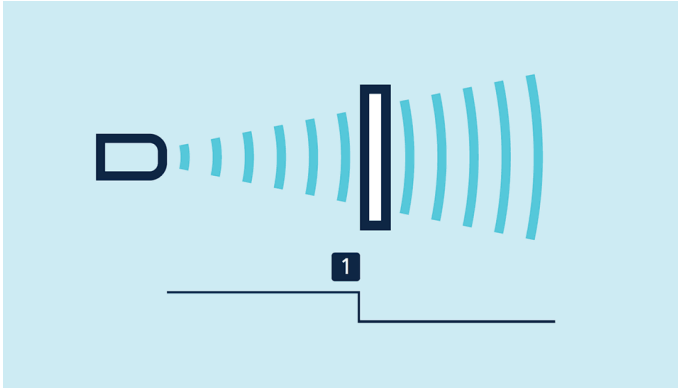

Teach-in of a switching point

Teach-in of a two-way reflective barrier

with a fixed reflector

- › Apply $+U_B$ to pin 5 for about 3 seconds
- › Then apply $+U_B$ to pin 5 again for about 10 seconds

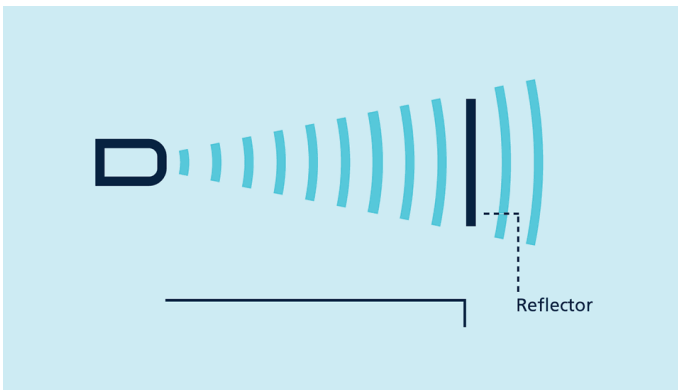

Teach-in of a two-way reflective barrier

For configuration of a window

- › Place object at the near edge of the window (1)
- › Apply $+U_B$ to pin 5 for about 3 seconds
- › Then move the object to the far edge of the window (2)
- › Then apply $+U_B$ to pin 5 again for about 1 seconds

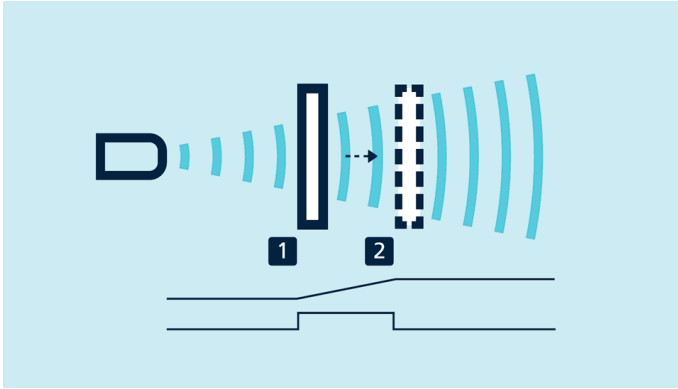

Teach-in of an analogue characteristic or a window with two switching points

NCC/NOG

and rising/falling analogue characteristic curve can also be set via pin 5.

One green and one yellow LED

indicate the state of the output and support microsonic Teach-in.

LinkControl

optionally permits the extensive parameterisation of pico+ sensors. The LCA-2 **LinkControl adapter** , which is available as an accessory, can be used to connect pico+ sensors to the PC.



Sensor connected to the PC via LCA-2 for programming

Easy to synchronise

A number of pico+ sensors can be run closely packed in applications synchronised to stop them from influencing one another. To this end, the sync mode has to be activated and all the sensors are to be electrically connected one to another with pin 5.

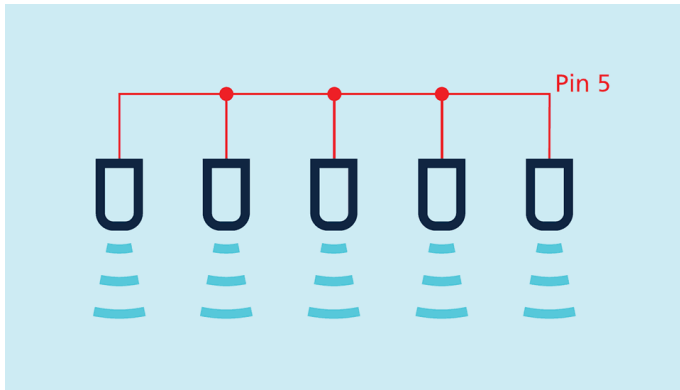

Synchronisation using pin 5

If more than 10 sensors must be synchronised, this can be carried out with the **SyncBox1** , which is available as an accessory.

In instances of where a number of sensors are run at an IO-Link master, then the master's function is to assume synchronisation.



Synchronised sensor cell in glass bottle production

Updated to IO-Link version 1.1

The pico+ sensors with the extension „/A“ in the order name are updated to IO-Link version 1.1 and support the Smart Sensor Profile. Please note that these sensor with the updated IO-Link version do not support IO-Link version 1.0 any longer. For example, when replacing pico+15/F with a **pico+15/F/A** you have to integrate the new device ID in the IO-Link master. In SIO mode, the sensors are compatible with each other. The predecessor models pico+xxx/F can be found in the [sensor archive](#).

pico+15/F/A

scale drawing

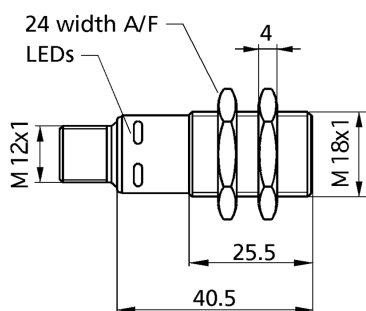

detection zone

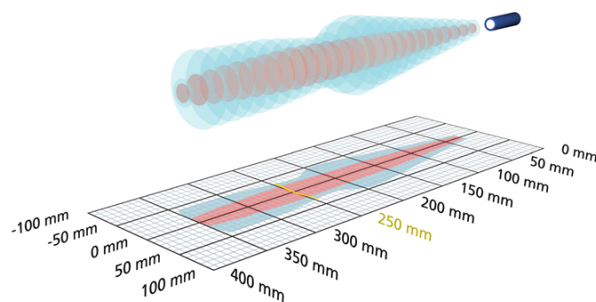

1 x Push-Pull



250 mm

measuring range	20 - 250 mm
design	cylindrical M18
operating mode	IO-Link proximity switch/reflective mode reflective barrier window mode
particularities	IO-Link Version 1.1 Smart Sensor Profile UL Listed

ultrasonic-specific

means of measurement	echo propagation time measurement
transducer frequency	380 kHz
blind zone	20 mm
operating range	150 mm
maximum range	250 mm
resolution	0.10 mm
reproducibility	± 0.15 %
accuracy	± 1 % (temperature drift internally compensated)

electrical data

operating voltage U_B	10 - 30 V d.c., reverse polarity protection
voltage ripple	± 10 %
no-load current consumption	≤ 40 mA
type of connection	5-pin M12 initiator plug

pico+15/F/A

outputs

output 1	switching output Push-Pull, $U_B-3\text{ V}$, $-U_B+3\text{ V}$, $I_{\max} = 100\text{ mA}$
switching hysteresis	2.0 mm
switching frequency	25 Hz
response time	32 ms
delay prior to availability	< 300 ms

inputs

input 1	com input synchronisation input teach-in input
---------	--

IO-Link

product name	pico+15/F/A
product ID	12500
SIO mode support	yes
COM mode	COM2 (38,4 kBaud)
min. cycle time	8 ms
format of process data	32 Bit PDI
content of process data	Bit 0: initial state Pin 4; Bit 8-15: scale (Int. 8); Bit 16-31: measured value (Int. 16)
ISDU paramter	Identification, measuring configuration, switched output, filter, temperature compensation, operation
system commands	SP1 Teach-in, SP2 Teach-in, factory settings
Smart Sensor Profile	yes
IODD version	IODD version 1.1

housing

material	brass sleeve, nickel-plated, plastic parts, PBT
ultrasonic transducer	polyurethane foam, epoxy resin with glass contents
max. tightening torque of nuts	15 Nm
class of protection to EN 60529	IP 67
operating temperature	-25°C to +70°C
storage temperature	-40°C to +85°C
weight	30 g
further versions	90° angular head
further versions	pico+15/WK/F/A

pico+15/F/A

technical features/characteristics

temperature compensation	yes
controls	com input
scope for settings	IO-Link LCA-2 with LinkControl Teach-in via com input on pin 5
Synchronisation	yes
multiplex	yes
indicators	1 x LED green: working, 1 x LED yellow: switch status
particularities	IO-Link Version 1.1 Smart Sensor Profile UL Listed

pin assignment

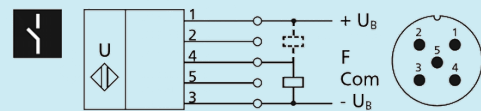

order no.

pico+15/F/A

The content of this document is subject to technical changes.
Specifications in this document are presented in a descriptive way
only. They do not warrant any product features.