



Extract from our online catalogue:

Ipc+100/WK/CFU

Current to: 2023-11-13



ipc+ well equipped: 2 Push-Pull switching outputs or 1 Push-Pull switching output with an analogue output in M18 housing.

HIGHLIGHTS

- › Analogue output 4–20 mA or 0–10 V plus 1 Push-Pull switching output in M18 design
- › IO-Link interface › for support of the new industry standard
- › Smart Sensor Profiles › more transparency between IO-Link Devices
- › Improved temperature compensation › adjustment to working conditions within 120 seconds
- › UL Listed to Canadian and US safety standards

BASICS

- › 2 Push-Pull switching outputs › pnp or npn basis
- › 4 detection ranges with a measurement range of 20 mm to 1.3 m
- › microsonic Teach-in on pin 5
- › 0.1 mm resolution
- › 10–30 V operating voltage
- › LinkControl › for configuration of sensors from a PC

Description

The lpc+ ultrasonic sensors

are optionally equipped with two Push-Pull switching outputs or an analogue output plus a Push-Pull switching output. The compact series with M18 threaded sleeves covers four detection ranges from 20 mm to 1.3 m.

Ultrasonic sensors with the Push-Pull output stage support SIO and IO-Link modes. Sensors with analogue output are optionally available with 4–20 mA current output or 0–10 V voltage output.

In SIO mode, sensors are configured using the microsonic Teach-in procedure on pin 5.

For the lpc+ sensor family

there are 2 output stages and 4 detection ranges available:



2 Push-Pull-switching outputs, optionally in pnp or npn circuitry with IO-Link interface



1 Push-Pull switching output and analogue output 4–20 mA or 0–10 V

Ultrasonic sensors with switching output have three operating modes:

- › Single switching point
- › Two-way reflective barrier
- › Window mode

Teach-in of a single switching point

- › Place object to be detected (1) at the desired distance
- › Apply $+U_B$ to pin 5 for about 3 seconds
- › Then apply $+U_B$ to pin 5 again for about 1 second

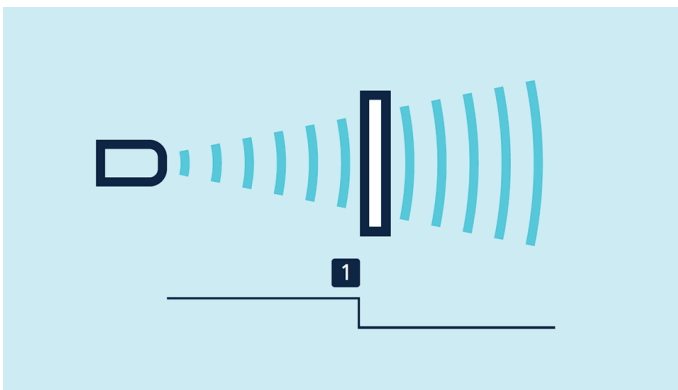

Teach-in of a two-way reflective barrier

with a fixed reflector

- › Apply $+U_B$ to pin 2 for about 3 seconds
- › Then apply $+U_B$ to pin 2 again for about 10 seconds

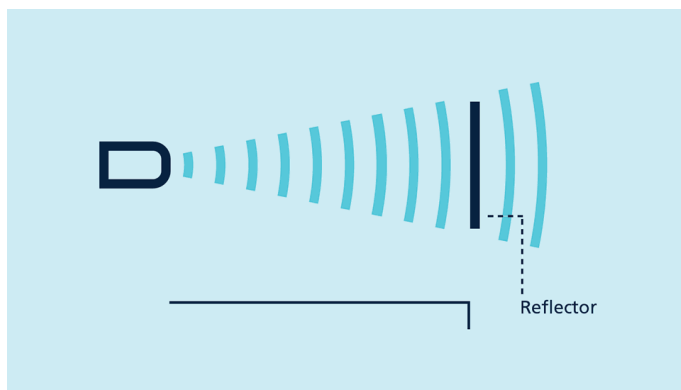

Teach-in of a two-way reflective barrier

For configuration of a window

- › Place object at the near edge of the window (1)
- › Apply $+U_B$ to pin 5 for about 3 seconds
- › Then move the object to the far edge of the window (2)
- › Then apply $+U_B$ to pin 5 again for about 1 second

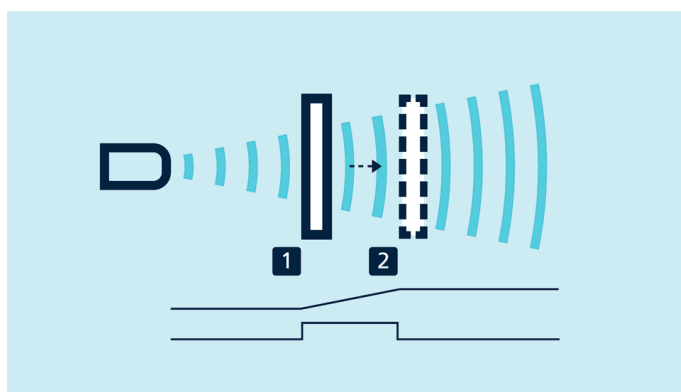

Teach-in of an analogue characteristic or a window with two switching points

NCC/NOG

and rising/falling analogue characteristic curve can also be set via pin 5.

One green and one yellow LED

indicate the state of the output and support microsonic Teach-in.

LinkControl

optionally permits the extensive parameterisation of lpc+ sensors. The LCA-2 **LinkControl adapter** , which is available as an accessory, can be used to connect lpc+ sensors to the PC.



Sensor connected to the PC via LCA-2 for programming

Easy to synchronise

A number of lpc+ ultrasonic sensors can be run closely packed in applications synchronised to stop them from influencing one another. To this end, the sync mode has to be activated and all the sensors are to be electrically connected one to another with pin 5.

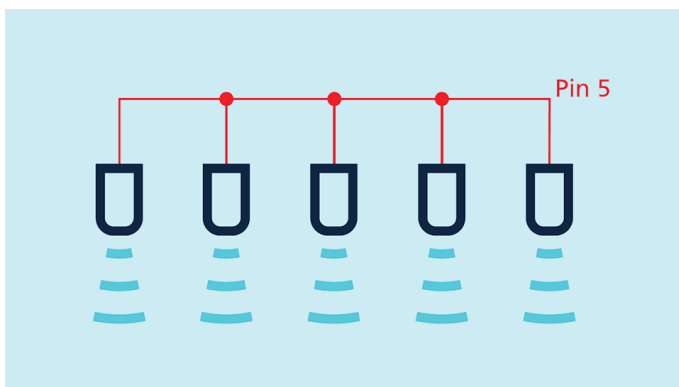

Synchronisation using pin 5

IO-Link integrated

in version 1.1. The lpc+ ultrasonic sensors are equipped with Smart Sensor Profile, which creates more transparency between IO-Link devices.

lpc+100/WK/CFU

scale drawing

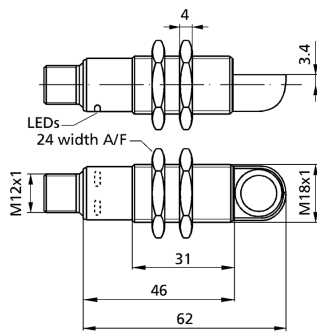

detection zone

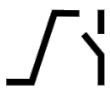
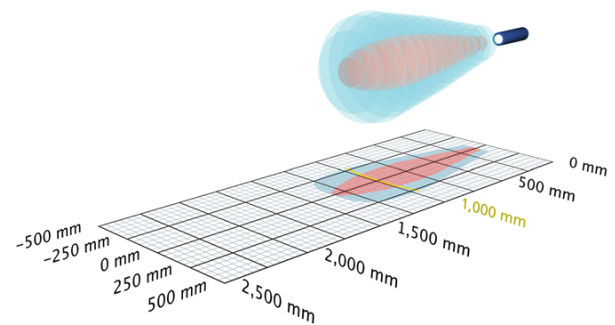

1 x Push-Pull + 1 x analog 0-10 V

 1,300 mm

measuring range	120 - 1.300 mm
design	cylindrical M18
operating mode	IO-Link proximity switch/reflective mode reflective barrier window mode analogue distance measurement
particularities	90° angular head IO-Link Smart Sensor Profile

ultrasonic-specific

means of measurement	echo propagation time measurement
transducer frequency	200 kHz
blind zone	120 mm
operating range	1,000 mm
maximum range	1,300 mm
reproducibility	± 0.15 %
accuracy	± 1 % (temperature drift internally compensated)

electrical data

operating voltage U_B	10 - 30 V d.c., reverse polarity protection
voltage ripple	± 10 %
no-load current consumption	≤ 50 mA
type of connection	5-pin M12 initiator plug

lpc+100/WK/CFU

outputs

output 1	analogue output voltage: 0-10 V, short-circuit-proof switchable rising/falling
output 2	switching output Push-Pull, $U_B=3\text{ V}$, $-U_B+3\text{ V}$, $I_{\max} = 100\text{ mA}$ NOC/NCC adjustable, short-circuit-proof
switching hysteresis	20 mm
switching frequency	10 Hz
response time	80 ms
delay prior to availability	< 300 ms

inputs

input 1	Com-Eingang Teach-in-Eingang Synchronisations-Eingang
---------	---

IO-Link

product name	lpc+100/WK/CFU
product ID	36321
SIO mode support	yes
COM mode	COM2 (38,4 kBaud)
min. cycle time	20 ms
format of process data	4 Byte
content of process data	Bit 0: initial state Pin 4; Bit 1: initial state Pin 2; Bit 8-15: scale (Int. 8); Bit 16-31: measured value (Int. 16)
ISDU paramter	Identification, measuring configuration, switched output, filter, temperature compensation, operation
system commands	SP1 Teach-in, SP2 Teach-in, factory settings
Smart Sensor Profile	yes
IODD version	IODD version 1.1

housing

material	brass sleeve, nickel-plated, plastic parts, PBT, PA
ultrasonic transducer	polyurethane foam, epoxy resin with glass contents
class of protection to EN 60529	IP 67
operating temperature	-25°C to +70°C
storage temperature	-40°C to +85°C
weight	40 g

lpc+100/WK/CFU

technical features/characteristics

temperature compensation	yes
controls	com input
scope for settings	Teach-in via com input on pin 5 LCA-2 with LinkControl IO-Link
Synchronisation	yes
multiplex	yes
indicators	2 x LED green, 2 x LED yellow
particularities	90° angular head IO-Link Smart Sensor Profile

pin assignment



order no.

lpc+100/WK/CFU

The content of this document is subject to technical changes.
Specifications in this document are presented in a descriptive way
only. They do not warrant any product features.