

Extract from our online catalogue:

Ics-130/DD/QP

Current to: 2023-11-13

Description

The lcs sensors

have a block-like plastic housing with four fixation bores, two of which are already equipped with M4 threaded bushings for eased mounting.

Two or three LEDs

indicate all operating statuses.

Three detection ranges and two output stages are available for selection:



2 pnp switched outputs

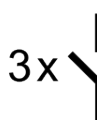

3 pnp switched outputs



1 analogue output 4–20 mA and 0–10 V

Via pin 5 at the M12 circular connector,

(Com input), the lcs sensors are set (Teach-in): Switched output D1 is set by connecting pin 5 to $+U_B$, while switched output D2 is set by connecting pin 5 to $-U_B$. Also the sensors with analogue output are set via pin 5.

The lcs sensors with switched output offer three operating modes:

- › Single switching point
- › Two-way reflective barrier
- › Window mode

Teach-in of a single switching point

- › Place object to be detected (1) at the desired distance
- › Apply $+U_B$ to pin 5 for about 3 seconds
- › Then apply $+U_B$ to pin 5 again for about 1 seconds

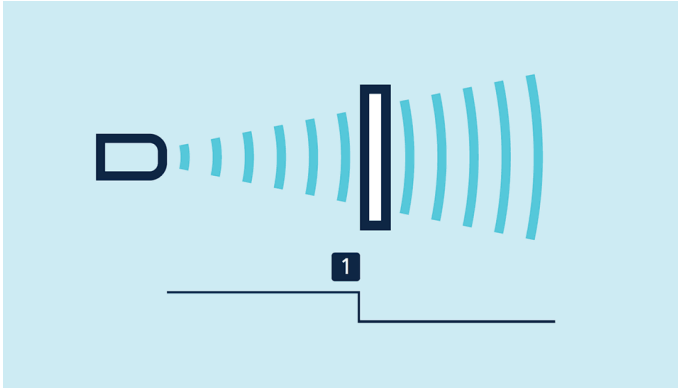

Teach-in of a switching point

Teach-in of a two-way reflective barrier

with a fixed reflector

- › Apply $+U_B$ to pin 5 for about 3 seconds
- › Then apply $+U_B$ to pin 5 again for about 10 seconds

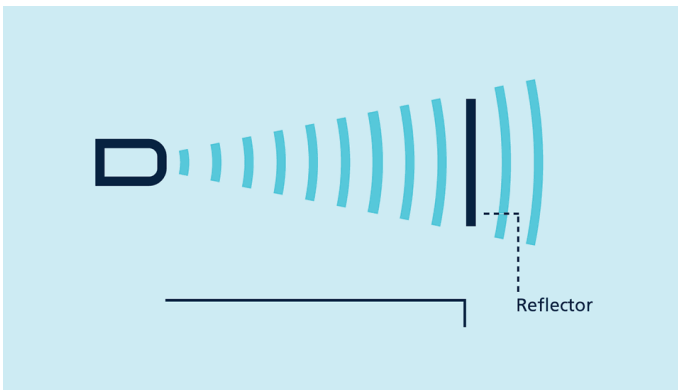

Teach-in of a two-way reflective barrier

For configuration of a window

- › Place object at the near edge of the window (1)
- › Apply $+U_B$ to pin 5 for about 3 seconds
- › Then move the object to the far edge of the window (2)
- › Then apply $+U_B$ to pin 5 again for about 1 seconds

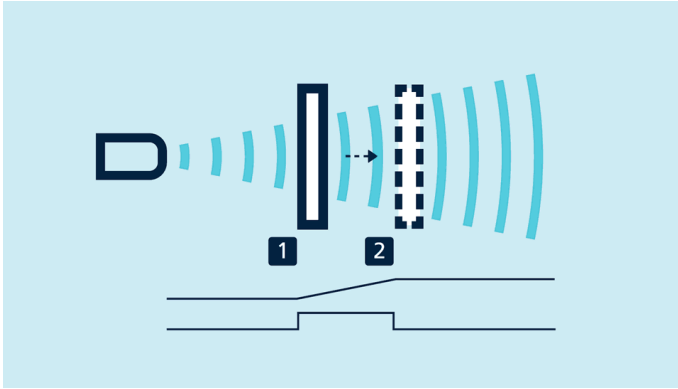

Teach-in of an analogue characteristic or a window with two switching points

NCC/NOG

and rising/falling analogue characteristic curve can also be set via pin 5.

The analogue sensor

checks the load connected to the output and then automatically switch to 4–20 mA current output or 0–10 V voltage output to ensure maximum ease of handling.

The Ics-25/DDD is equipped with three pnp switched outputs

which are set with the help of the **Link-Control adapter** LCA-2. In addition to this “offline” programming, all Ics sensors can also be parameterised on the PC with the LCA-2 and the **Link-Control software** .

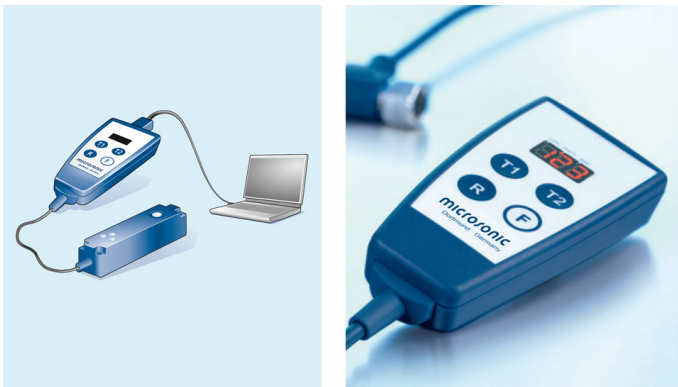

Sensor connected to the PC via LCA-2 for programming

Synchronisation

permits the simultaneous use of multiple mic sensors in an application. To avoid mutual interference, the sensors can be synchronised with one another. To do this, all the sensors are electrically connected on pin 5.

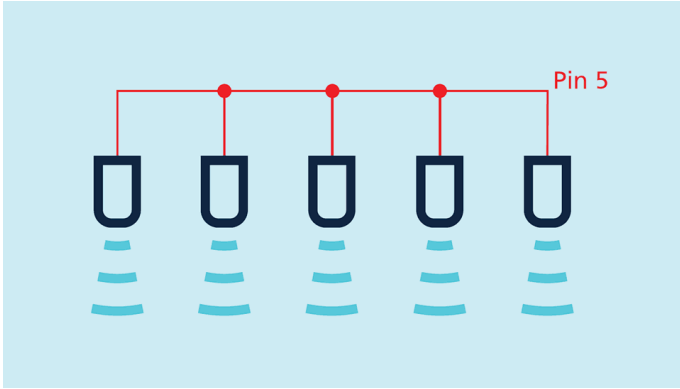

Synchronisation using pin 5

Ics-130/DD/QP

scale drawing

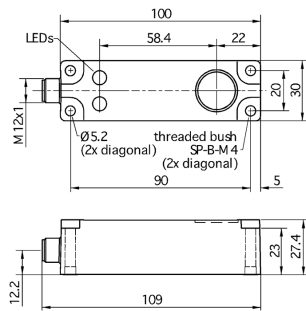

detection zone

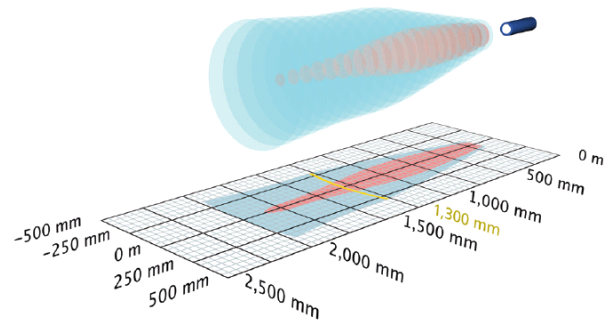

2 x pnp



2,000 mm

measuring range	200 - 2.000 mm
design	cuboidal
operating mode	proximity switch/reflective mode reflective barrier window mode
particularities	flat housing lateral sound exit

ultrasonic-specific

means of measurement	echo propagation time measurement
transducer frequency	200 kHz
blind zone	200 mm
operating range	1,300 mm
maximum range	2,000 mm
resolution	0.18 mm
reproducibility	± 0.15 %
accuracy	± 1 % (temperature drift internally compensated)

electrical data

operating voltage U_B	9 - 30 V d.c., reverse polarity protection
voltage ripple	± 10 %
no-load current consumption	≤ 70 mA
type of connection	5-pin M12 initiator plug

Ics-130/DD/QP

outputs

output 1	switching output pnp: $I_{\max} = 200 \text{ mA}$ ($U_B = 2V$) NOC/NCC adjustable, short-circuit-proof
output 2	switching output pnp: $I_{\max} = 200 \text{ mA}$ ($U_B = 2V$) NOC/NCC adjustable, short-circuit-proof
switching hysteresis	20 mm
switching frequency	6 Hz
response time	110 ms
delay prior to availability	< 300 ms

inputs

input 1	com input teach-in input
---------	-----------------------------

housing

material	PBT
ultrasonic transducer	polyurethane foam, epoxy resin with glass contents
class of protection to EN 60529	IP 65
operating temperature	-25°C to +70°C
storage temperature	-40°C to +85°C
weight	200 g

technical features/characteristics

temperature compensation	yes
controls	com input control input
scope for settings	Teach-in via com input on pin 5 LCA-2 with LinkControl
Synchronisation	yes
multiplex	no
indicators	2 x three-colour LED
particularities	flat housing lateral sound exit

Ics-130/DD/QP

pin assignment

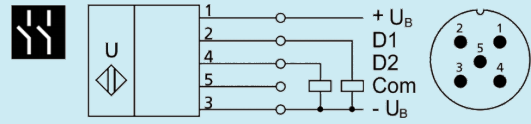

order no.

Ics-130/DD/QP

The content of this document is subject to technical changes.
Specifications in this document are presented in a descriptive way
only. They do not warrant any product features.